

Dell PowerEdge R420xr Getting Started Guide

Regulatory Model: E27S Series
Regulatory Type: E27S001



Notes, Cautions, and Warnings

 **NOTE:** A NOTE indicates important information that helps you make better use of your computer.

 **CAUTION:** A CAUTION indicates either potential damage to hardware or loss of data and tells you how to avoid the problem.

 **WARNING:** A WARNING indicates a potential for property damage, personal injury, or death.

Copyright © 2014 Dell Inc. All rights reserved. This product is protected by U.S. and international copyright and intellectual property laws. Dell™ and the Dell logo are trademarks of Dell Inc. in the United States and/or other jurisdictions. All other marks and names mentioned herein may be trademarks of their respective companies.

Installation And Configuration

 **WARNING:** Before performing the following procedure, review the safety instructions that came with the system.

Unpacking A Rack System

Unpack your system and identify each item.

Assemble the rails and install the system in the rack following the safety instructions and the rack installation instructions provided with your system.

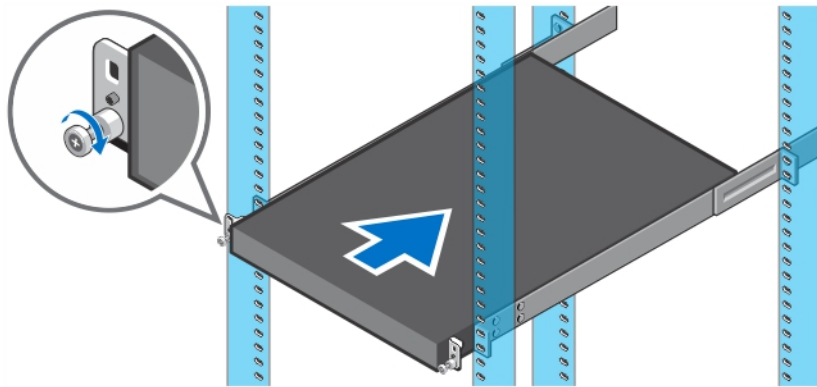

Figure 1. Installing the System in a Rack.

Optional—Connecting The Keyboard, Mouse, And Monitor

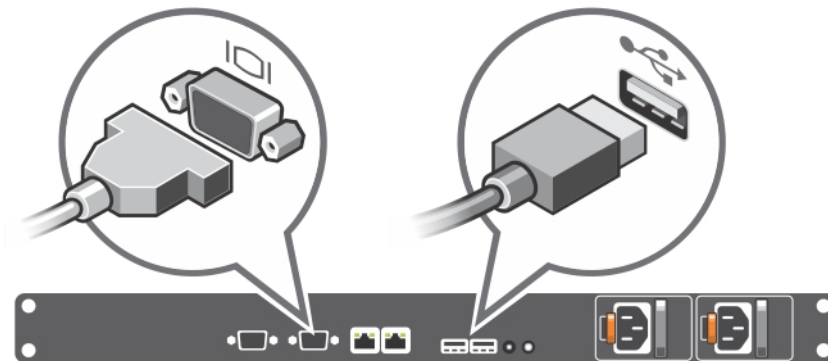

Figure 2. Optional—Connecting the Keyboard, Mouse, and Monitor

Connect the keyboard, mouse, and monitor (optional).

The connectors on the back of your system have icons indicating which cable to plug into each connector. Be sure to tighten the screws (if any) on the monitor's cable connector.

Connecting The Power Cable(s)

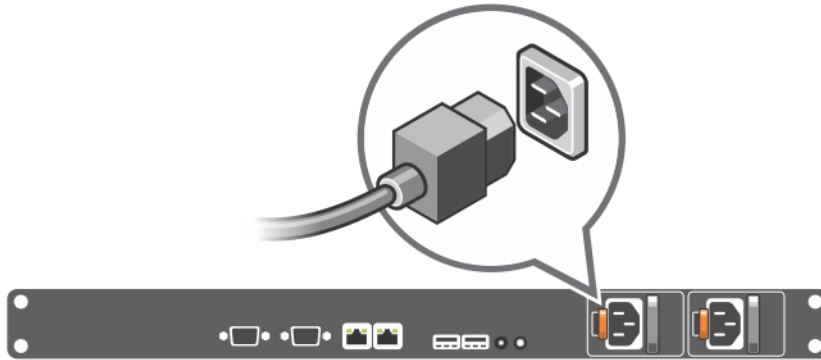

Figure 3. Connecting the Power Cable(s)

Connect the system's power cable(s) to the system and, if a monitor is used, connect the monitor's power cable to the monitor.

Securing The Power Cable(s)

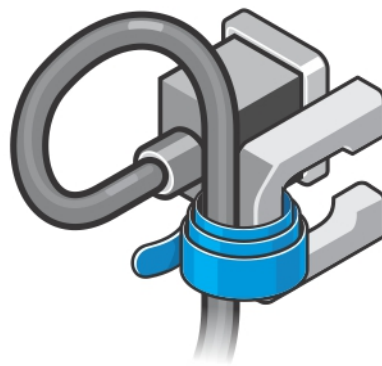

Figure 4. Securing the Power Cable(s)

Bend the system power cable(s), as shown in the illustration, and attach to the cable strap.

Plug the other end of the power cable(s) into a grounded electrical outlet or a separate power source such as an uninterruptible power supply (UPS) or a power distribution unit (PDU).

Turning On The System

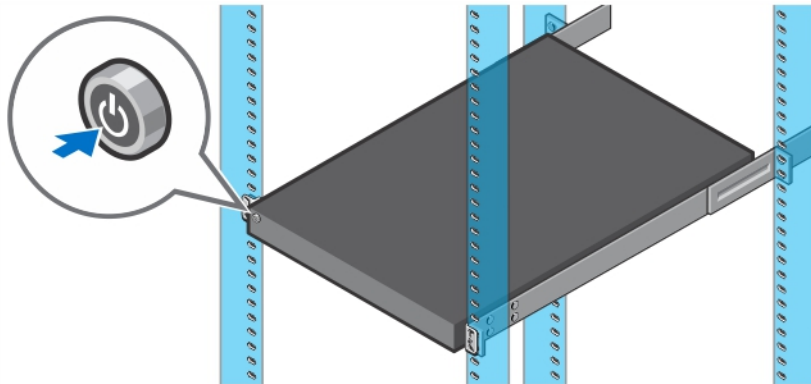

Figure 5. Turning on the System

Press the power button on the system. The power indicator should light.

Installing The Optional Bezel

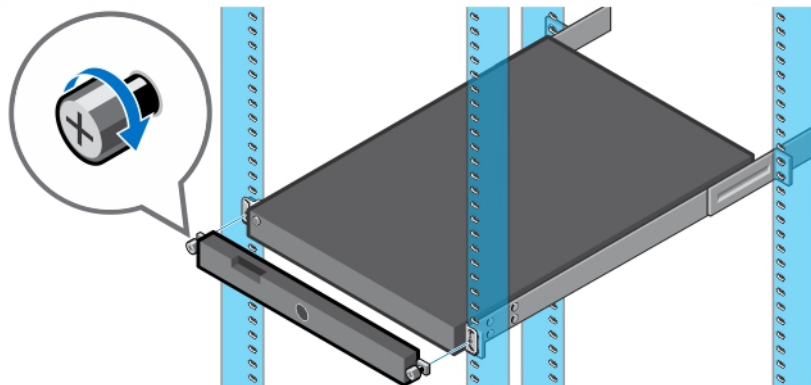

Figure 6. Installing the Optional Bezel

Install the bezel (optional).

Complete The Operating System Setup

If you purchased a system with a pre-installed operating system, see the operating system documentation that shipped with your system. To install an operating system for the first time, see the installation and configuration documentation for your operating system. Be sure that the operating system is installed before installing hardware or software not purchased with the system.

 **NOTE:** For latest information on supported operating systems, see [dell.com/ossupport](https://www.dell.com/ossupport).

Dell Software License Agreement

Before using your system, read the Dell Software License Agreement that came with your system. You must consider any media of Dell-installed software as BACKUP copies of the software installed on your system's hard drive. If you do not accept the terms of the agreement, call the customer assistance telephone number. For customers in the United States, call 800-WWW-DELL (800-999-3355). For customers outside the United States, see dell.com/support and select your country or region from the top left of the page.

Other Information You May Need

 **WARNING:** See the safety and regulatory information that shipped with your system. Warranty information may be included within this document or as a separate document.

- The *Owner's Manual* provides information about system features and describes how to troubleshoot the system and install or replace system components. This document is available online at dell.com/support/manuals.
- The rack documentation included with your rack solution describes how to install your system into a rack, if required.
- Any media that ships with your system that provides documentation and tools for configuring and managing your system, including those pertaining to the operating system, system management software, system updates, and system components that you purchased with your system.

 **NOTE:** Always check for updates on dell.com/support/manuals and read the updates first because they often supersede information in other documents.

 **NOTE:** When upgrading your system, it is recommended that you download and install the latest BIOS, driver, and systems management firmware on your system from dell.com/support.

Obtaining Technical Assistance

If you do not understand a procedure in this guide or if the system does not perform as expected, see your system Owner's Manual. Dell offers comprehensive hardware training and certification. See dell.com/training for more information. This service may not be offered in all locations.

NOM Information (Mexico Only)

The following information is provided on the device described in this document in compliance with the requirements of the official Mexican standards (NOM):

Importer:	Dell Inc. de México, S.A. de C.V. Paseo de la Reforma 2620 -11º Piso Col. Lomas Altas 11950 México, D.F.
Model number:	E27S
Supply voltage:	100 V CA–240 V CA
Frequency:	50 Hz/60 Hz

Current consumption: 7.4 A – 3.7 A (X2) (with 550 W Redundant AC Power Supply Unit)

Technical Specifications

 **NOTE:** The following specifications are only those required by law to ship with your system. For a complete and current listing of the specifications for your system, go to dell.com/support.

Power

AC Power Supply (per power supply)

Wattage	550 W
Heat dissipation	2132 BTU/hr maximum (redundant, 550 W power supply)

 **NOTE:** Heat dissipation is calculated using the power supply wattage rating.

Voltage	100–240 V AC, autoranging, 50/60 Hz
---------	-------------------------------------

 **NOTE:** This system is also designed to be connected to IT power systems with a phase to phase voltage not exceeding 230 V.

Battery

Coin-cell battery	3 V CR2032 Lithium coin cell
-------------------	------------------------------

Physical

Height	42.8 mm (1.6 inch)
Width	
With rack latches	486.0 mm (19.1 inch)
Without rack latches	434.0 mm (17.0 inch)
Depth (excludes bezel)	508.0 mm (20.0 inch)
Weight (maximum)	12.2 kg (27.0 lb)
Weight (empty)	8.8 kg (19.5 lb)

Environmental

 **NOTE:** For additional information about environmental measurements for specific system configurations, see dell.com/environmental_datasheets.

Temperature

Maximum Temperature Gradient (Operating and Storage)	20 °C/h (36 °F/h)
Storage Temperature Limits	–40 °C to 65 °C (–40 °F to 149 °F)

Environmental

Temperature (Continuous Operation)

Temperature Ranges (for altitude less than 950 m or 3117 ft)	10 °C to 45 °C (50 °F to 113 °F) with no direct sunlight on the equipment.
Humidity Percentage Range	10% to 80% Relative Humidity with 26 °C (78.8 °F) maximum dew point.

Relative Humidity

Storage	5% to 95% RH with 33 °C (91 °F) maximum dew point. Atmosphere must be non-condensing at all times.
---------	--

Vibration

Operating	MIL-STD-810G, Method 514.6, Figure 514.6D-9, 0.00220783 g ² /Hz at 10-500 Hz (overall 1.04 G _{rms}), 1 hour per axis
Non-operating	MIL-STD-810G, Method 514.6, Figure 514.6, Procedure I, Category 4, Figure 514.6C-1 (US highway truck vibration), Vertical: 5-500 Hz at 1.04 G _{rms} , Transverse: 5-500 Hz at 0.204 G _{rms} , Longitudinal: 5-500 Hz at 0.740 G _{rms} , 1 hour per axis

Shock

Operating	MIL-STD-810G, Method 516.6, Procedure I, 20G for rotational hard drives and 40G for solid state drives, 11 ms, saw tooth, 3 shocks, +/- per axis
Non-operating	MIL-STD-810G, Method 516.6, Procedure V, 40G, 11 ms, saw tooth, 3 shocks, +/- per axis

Maximum Altitude

Operating	3,048 m (10,000 ft).
Storage	12,192 m (40,000 ft).

Operating Altitude De-rating

Up to 35 °C (95 °F)	Maximum temperature is reduced by 1 °C/300 m (1 °F/547 ft) above 950 m (3,117 ft).
35 °C to 40 °C (95 °F to 104 °F)	Maximum temperature is reduced by 1 °C/175 m (1 °F/319 ft) above 950 m (3,117 ft).
40 °C to 45 °C (104 °F to 113 °F)	Maximum temperature is reduced by 1 °C/125 m (1 °F/228 ft) above 950 m (3,117 ft).

Particulate Contamination

Environmental

 **NOTE:** This section defines the limits to help avoid IT equipment damage and/or failure from particulates and gaseous contamination. If it is determined that levels of particulates or gaseous pollution are beyond the limits specified below and are the reason for the damage and/or failures to your equipment, it may be necessary for you to re-mediate the environmental conditions that are causing the damage and/or failures. Re-mediation of environmental conditions will be the responsibility of the customer.

Air Filtration

 **NOTE:** Applies to data center environments only. Air filtration requirements do not apply to IT equipment designed to be used outside a data center, in environments such as an office or factory floor.

Data center air filtration as defined by ISO Class 8 per ISO 14644-1 with a 95% upper confidence limit.

 **NOTE:** Air entering the data center must have MERV11 or MERV13 filtration.

Conductive Dust

 **NOTE:** Applies to data center and non-data center environments.

Air must be free of conductive dust, zinc whiskers, or other conductive particles.

Corrosive Dust

 **NOTE:** Applies to data center and non-data center environments.

- Air must be free of corrosive dust.
- Residual dust present in the air must have a deliquescent point less than 60% relative humidity.

Gaseous Contamination

 **NOTE:** Maximum corrosive contaminant levels measured at $\leq 50\%$ relative humidity.

Copper Coupon Corrosion Rate

<300 Å/month per Class G1 as defined by ANSI/ISA71.04-1985.

Silver Coupon Corrosion Rate

<200 Å/month as defined by AHSRAE TC9.9.